

## STRIP BRUSH RANGE **AND ALUMINIUM PROFILES**

*For all applications | Wide array of lengths and materials | Available separately*

Some applications always demand brushes specially tailored for their purpose. Therefore, we offer the following strip brush range with various filament options and suitable profiles that can be purchased separately.

N°2.5

N°3.5

N°5

N°8

N°10

### **Filaments**

Available in a wide array of lengths and materials (page 4-6). When choosing the optimal filling material for your brush, you need to consider several factors before creating your perfect strip brush. Selecting the right filling material is crucial to ensure that the strip brush functions effectively, efficiently, and safely in its intended application, saving time, resources, and potential issues in the long run.

### **Aluminium profiles**

These profiles can be used in a wide range of industries and applications, from industrial settings to architectural and decorative purposes. The use of lightweight aluminium profiles for strip brushes combines durability, corrosion resistance, customization capabilities, and other benefits such as; thermal conductivity, aesthetic appearance, versatility, eco-friendly, secure attachment and compatibility to enhance the overall effectiveness of the brush assembly.

*There are many options and combinations possible to suit your application, simply ask and we'll be happy to help.*



## Lengths and trim lengths

Standard lengths of 1 or 3 meters are available from stock, featuring trim lengths of 25 or 55 mm and a plastic filling material of 0.15 mm. Upon request, lengths ranging from 5 to 6000 mm with trim lengths from 3 to 100 mm, can be provided, depending on the profile. When needed, trim lengths of up to 1100 mm are possible, depending on the filling material.

(scale 1:1)



STRIP BRUSHES N°2.5
<b>U widths</b>
2.5x3

STRIP BRUSHES N°3.5
<b>U widths</b>
3.5x3.5

STRIP BRUSHES N°5
<b>U widths</b>
5x5
5x6

STRIP BRUSH N°8
<b>U widths</b>
8 x 8

STRIP BRUSH N°10
<b>U widths</b>
10 x 10

All dimensions in mm.

# STRIP BRUSHES

## ALUMINIUM H-PROFILES FOR STRIP BRUSH RANGE

### Profile options

- Available colours are untreated or silver anodised
- Standard lengths of 1m and 3m
- Special lengths and colours are available upon request

Contact us for special holders and requirements.

TECHNICAL SPECIFICATIONS H-PROFILES			
Model	Suited for	Width (mm)	Height (mm)
12500	n° 2.5	5.3	13
13530*	n° 3.5	6	16
13538	n° 3.5	6	25
15130	n° 5	8	25
15330	n° 5	8	35
13536	n° 3.5	6	50
15230	n° 5	8	50

### Aluminium

(scale 1:1)

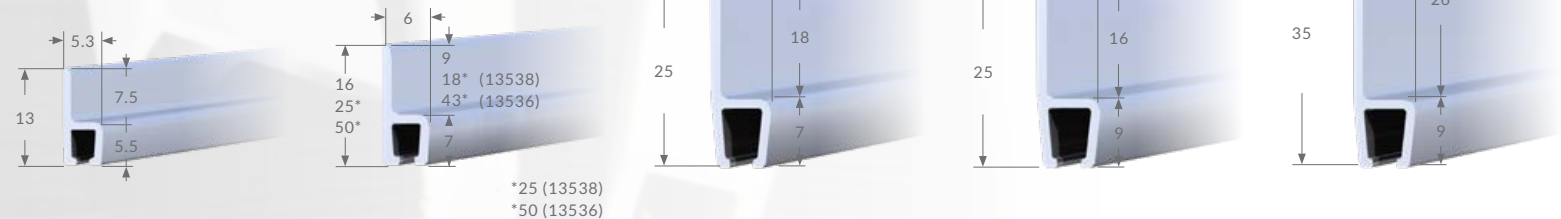

12500	
Material	Thickness
Aluminium	1.2

N°2.5

13530*	
Material	Thickness
Aluminium	1.2

N°3.5

\*compatible strip brush

13538	
Material	Thickness
Aluminium	1.2

N°3.5

15130	
Material	Thickness
Aluminium	1.2

N°5

15330	
Material	Thickness
Aluminium	1.2

N°5

All dimensions in mm.

## TECHNICAL SPECIFICATIONS H-PROFILES

Model	Suited for	Width (mm)	Height (mm)
16650	n°8	12.6	50
10000	n°10	17	60
13013	n°13	19.5	60
16660	n°8	13.5	112

(scale 1:1)

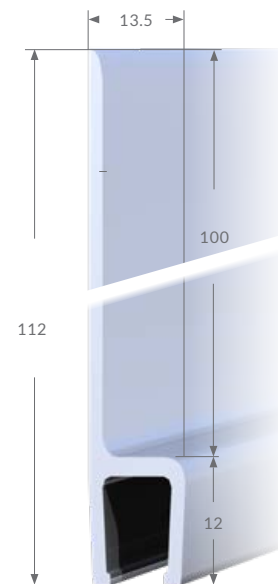
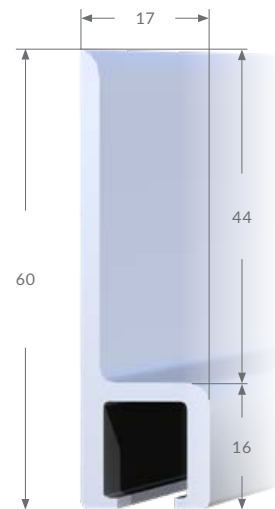
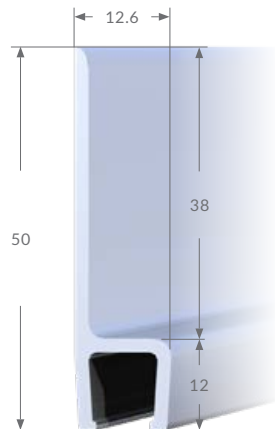
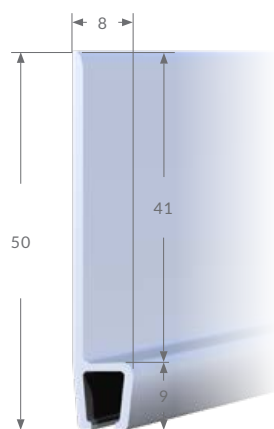
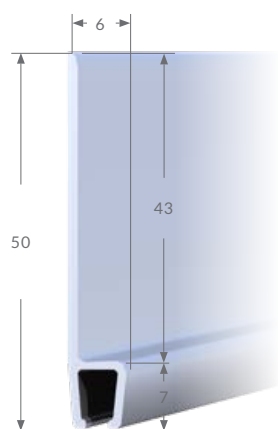

### 13536

Material	Thickness
Aluminium	1.2

N°3.5

### 15230

Material	Thickness
Aluminium	1.2

N°5

### 16650

Material	Thickness
Aluminium	1.8

N°8

### 10000

Material	Thickness
Aluminium	2.5

N°10

### 16660

Material	Thickness
Aluminium	2.0

N°8

All dimensions in mm.

# STRIP BRUSHES

## ALUMINIUM F-PROFILES FOR STRIP BRUSH RANGE

### Profile options

- Available colours are untreated or silver anodised
- Standard lengths of 1m and 3m
- Special lengths and colours are available upon request

Contact us for special holders and requirements.

TECHNICAL SPECIFICATIONS F PROFILES			
Model	Suited for	Width (mm)	Height (mm)
12600	n° 2.5	14	5.5
13529*	n° 3.5	16	7
15129	n° 5	25	9
16640	n° 8	50	12
16641	n° 8	40	12
16642	n° 8	35	13

\*Different sizes or colours available

### Aluminium

(scale 1:1)

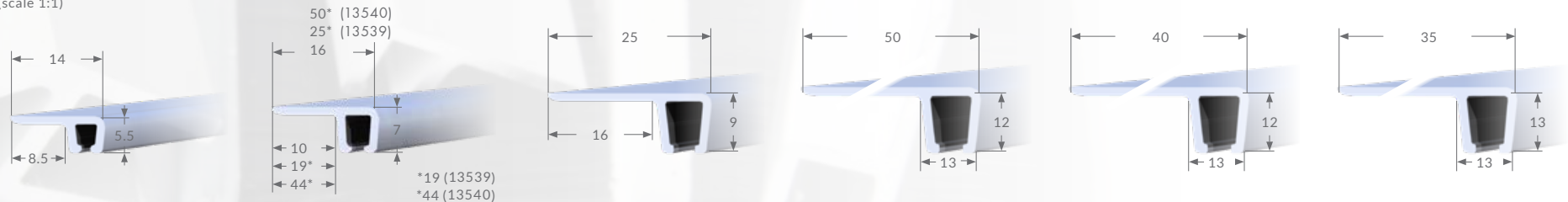

12600	
Material	Thickness
Aluminium	1.2

N°2.5

13529*	
Material	Thickness
Aluminium	1.2

N°3.5

\*compatible strip brush

15129	
Material	Thickness
Aluminium	1.2

N°5

16640	
Material	Thickness
Aluminium	1.8

N°8

16641	
Material	Thickness
Aluminium	1.8

N°8

16642	
Material	Thickness
Aluminium	1.8

N°8

All dimensions in mm.

## ALUMINIUM Y-PROFILES FOR STRIP BRUSH RANGE

### Profile options

- Available colours are untreated or silver anodised
- Standard lengths of 1m and 3m
- Special lengths and colours are available upon request

Contact us for special holders and requirements.

### Aluminium

(scale 1:1)

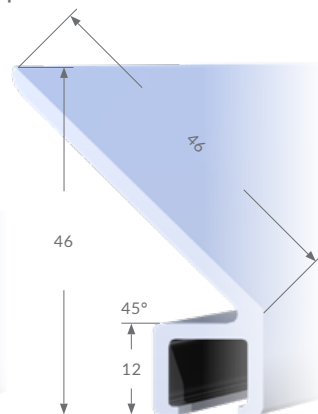
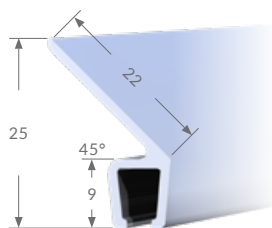
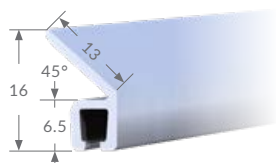

13535	
Material	Thickness
Aluminium	1.2

15135	
Material	Thickness
Aluminium	1.2

16665	
Material	Thickness
Aluminium	1

N°3.5

N°5

N°8

All dimensions in mm.

TECHNICAL SPECIFICATIONS Y PROFILE		
Model	Suited for	Height (mm)
13535	n° 3.5	16
15135	n° 5	25
16665	n° 8	46

